

// **The New SupraMatic: Strong. Safe. Supra-Fast.**



## Garage Door Operators

Convenient and Secure – for You and Your Home



Technology that inspires and  
leaves nothing to be desired



## Choose the Premium Quality

of the door and operator specialist Hörmann

You can't help but enthuse about Hörmann garage door operators because their innovative technology makes your life easier, safer and definitely more enjoyable. Every day, every night and in all weathers.

# Hörmann garage door operators

## Quick, safe, reliable

### SupraMatic // NEW

The supra-fast operator with a myriad of additional functions, for example, the 50 % higher opening speed and the brighter, separately switchable halogen light for a better-lit garage.

### ProMatic

The good-value starter model to introduce you to the premium quality of Hörmann products. With all the benefits of Hörmann's proven operator technology.

### Certified safety

Hörmann garage door operators are tested and certified by sworn independent experts, as individual units and in combination with all Hörmann garage doors, but also together with many non-Hörmann garage doors, in accordance with the stringent safety requirements and regulations of the European Standard 13241-1. This makes your decision in every sense safe and sound. Guaranteed.



### Automatic door latching in the operator boom

When the door closes, the door security kit automatically engages into the boom stop. This protects the door effectively from being levered open.

The patented door latching system is a mechanical device, so is guaranteed to function even in the event of a power failure. That's why during holiday periods you can safely switch the operator off.

### A Hörmann Patent

### Reliable automatic cut-out instantly counteracts obstructions

On encountering an obstruction, the closing door stops immediately and is automatically raised by approx. 30 cm, providing sufficient space to allow the obstruction to be cleared. An additional photocell, installed parallel to the ground, increases this safety even further (optional extra).

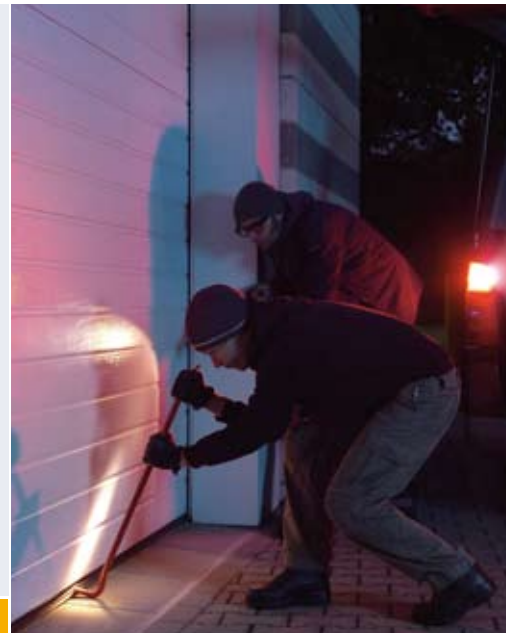

### Entrance gate operators

Open the entrance to your drive with the same control elements (e.g. hand transmitter, digital coder) as you use for your garage door. Everything is compatible and perfectly matched. Ask your Hörmann specialist dealer.

\* Guarantee terms, specifications and further information on Hörmann products can be found on the Hörmann website at: [www.hoermann.com](http://www.hoermann.com).

**NEW SupraMatic – the supra-fast operator  
with an array of additional functions**



## Strong. Safe. Supra-Fast.

The **turbo** among the garage door operators

You will find this combination of speed and convenience fascinating. Your sectional garage door opens faster, you can switch on the garage lighting separately and as regards the additional functions, you'll not want to do without them ever again.



## SupraMatic E

Peak force: 800 N

Opening speed: **max. 22 cm /s**

Door width: up to max. 5500 mm,

For a maximum of 25 door cycles (open/close) per day

## SupraMatic P

Peak force: 1000 N

Opening speed: **max. 22 cm /s**

Door width: up to max. 5500 mm,

Also suitable for heavy timber doors and garage doors with integrated wicket door

For a maximum of 50 door cycles (open/close) per day

- **Door opens faster**

Due to the higher opening speed of up to 50 % for sectional doors, you get into your garage faster.

- **Separately switchable halogen lighting**

Via your hand transmitter\* or the IT 3b optional internal push-button unit, the operator lighting can be switched separately on and off.

- **Additional opening height**

With the individually adjustable second opening height you can ventilate your garage without having to fully open the door.

- **Elegant aesthetics**

Thanks to the operator hood in brushed aluminium

\* only possible if the “second opening height function” is deactivated.

## With proven Hörmann technology

- **Adjustable “soft” start and “soft” stop:** saves wear on the door and operator, ensures a quiet-running door at every stage of opening and closing
- **Automatic door latching:** Optimum mechanical protection against levering open of the door (Hörmann Patent)
- **Reliable automatic cut-out:** stops the door instantly on encountering an obstruction
- **Maintenance-free toothed belt with automatic retensioning (Hörmann Patent)**
- **Inside emergency release**
- **With 4-button hand transmitter as standard // NEW**
- **Broad range of accessories**
- **Simple and quick to install thanks to perfectly prepared fixings**
- **Adjustable lighting (1-5 minutes)**



The opening speed, now up to 50 % faster, more than compensates for the longer distance that sectional doors have to travel on account of their type of construction. The new SupraMatic is therefore particularly suitable for sectional doors.

**Compare the opening speed of the new SupraMatic operator with conventional operators – and take a look at our short film at [www.hoermann.com](http://www.hoermann.com).**

**ProMatic – the inexpensive starter model  
and ideal introduction to Hörmann’s premium quality operators**



**Ingenious. Inexpensive. Invaluable.**

More than you expect

The ProMatic garage door operators feature the same proven Hörmann technology as all Hörmann premium operators. This guarantees reliable function – at an attractive price.



## ProMatic

Peak force: 650 N

Opening speed: max. 13 cm /s

Door width: up to max. 5000 mm,

For a maximum of 5 door cycles (open/close) per day

## ProMatic P

Peak force: 750 N

Opening speed: max. 13 cm /s

Door width: up to max. 5500 mm,

Also suitable for larger and heavier doors.

For a maximum of 10 door cycles (open/close) per day

## With proven Hörmann technology

- **Adjustable “soft” start and “soft” stop:** saves wear on the door and operator, quiet-running door at every stage of opening and closing
- **Automatic door latching:** optimum mechanical protection against levering open of the door (Hörmann Patent)
- **Reliable automatic cut-out:** stops the door instantly on encountering an obstruction
- **Maintenance-free toothed belt with automatic retensioning (Hörmann Patent)**
- **Inside emergency release**
- **With 4-button hand transmitter as standard // NEW**
- **Broad range of accessories**
- **Simple and quick to install thanks to perfectly prepared fixings**
- **3 minutes light**



Both the SupraMatic and ProMatic include 4-button hand transmitters as standard features.

**ProMatic Akku – the practical operator  
for garages without a mains connection**



## The New-Found Freedom

No longer dependent on the mains thanks to a portable accumulator

Now, even a garage without a mains connection, can still offer you the comfort and convenience of an electric operator. The ProMatic Akku makes it possible. Easy to transport, it can be recharged in a matter of hours, e.g. overnight.



## ProMatic Akku

Peak force: 400 N

Opening speed: max. 13 cm /s

Door width: up to max. 3000 mm

For a maximum of 4 door cycles (open/close) per day

## Accumulator

Capacity: approx. 40 days\*

Charging time: 5-10 hours\*\*

Weight: 8.8 kg

Dimensions: 320 x 220 x 115 mm

## Solar Module (optional)

Including installation materials,  
10 metre long connecting lead and charge controller.

Dimensions: 300 x 400 mm

\* based on an average of 4 door cycles per day and  
an ambient temperature of 20° Celsius

\*\* depending on the charging state

- **Power for up to 40 days**

You can enjoy the operating comfort of a garage door operator for up to 40 days without having to recharge the accumulator in between.

- **Easy overnight recharging**

Similar to the recharging of a mobile phone, the accumulator is simply connected to a power outlet using the supplied charger. The accumulator then fully recharges overnight and your operator is ready for use again.

- **Particularly convenient**

The optional solar module saves you having to recharge the accumulator manually. The module is simply mounted to the side or on top of the garage.

## With proven Hörmann technology

- **Adjustable “soft” start and “soft” stop: saves wear on the door and operator, a quiet-running door at every stage of opening and closing**
- **Automatic door latching: Optimum mechanical protection against levering open of the door (Hörmann Patent)**
- **Reliable automatic cut-out: stops the door instantly on encountering an obstruction**
- **Maintenance-free toothed belt with automatic retensioning (Hörmann Patent)**
- **Inside emergency release**
- **With 4-button hand transmitter as standard // NEW**
- **Broad range of accessories**
- **Simple and quick to install thanks to perfectly prepared fixings**
- **30 seconds light**



Thanks to the practical carrying handle and its light weight, the accumulator is easy to transport.



The solar module, the practical addition to the garage door operator ProMatic Akku

## Automatic door latching in the operator boom

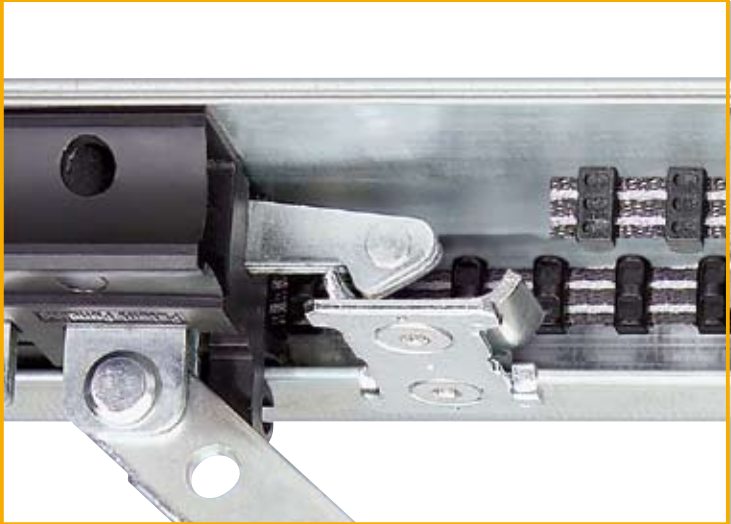

A Hörmann Patent



**When the door closes, the door security kit automatically engages into the boom stop. This provides effective security to prevent the door from being forced open. The device is entirely mechanical, so functions even during a power failure!**

### **Uninvited guests are left out in the cold!**

Hörmann garage door operators protect the door from being forcibly levered open. Would-be intruders don't stand a chance!

Hörmann customers enjoy security.  
Day and night. Night and day.

# Reliable and Safe

with automatic door latching

Hörmann's boom-guided operator technology is a patented system that offers you nothing but benefits: smooth-running reliable operation and automatic latching for increased security. You don't have to worry about a thing – it's all taken care of for you!

All Hörmann garage door operators are supplied with the robust, flat boom and patented toothed belt technology as standard features



### **Automatic belt tensioning**

The strong spring mechanism always tensions the toothed belt automatically, so smooth, even running is guaranteed.

### **Maintenance-free toothed belt**

Reinforced with aramid fibres, the Kevlar toothed belt is particularly tear-resistant and quiet-running. No greasing or oiling required. So nothing drips onto your car roof. A major advantage over chain and spindle drive operators.

### **Exceptionally flat boom**

The exceptionally flat boom - only 30 mm high - means that the operators are easy to mount onto any commercially available garage door and are therefore also ideal for retrofitting.

### **Trouble-free anchoring to the ceiling**

thanks to flexible, slide-aside perforated anchors

### **Inside emergency release**

to conveniently open the door from the inside in the event of a power failure.

### **Universal door link**

Suitable for all commercially available up-and-over doors and sectional doors.



Every Hörmann operator includes an ergonomically-styled 4-button hand transmitter as a standard feature



## Into the Garage by Remote Control

Because it's more convenient and safer

You stay seated in the car and operate the garage door in the same convenient way as you would your TV set. Press the button on the hand transmitter and drive straight into the garage. Protected from all weathers. Especially when it's dark the direct route is definitely the safest.



4-button hand transmitter with holder



4-button mini hand transmitter with key-ring



2-button micro hand transmitter with key-ring



4-button back-up hand transmitter  
The "general pass key" for the property manager.



#### Holder for the car sun visor

No more searching around in your bag or storage tray. You always know where the 4-button hand transmitter is, so it's always ready to hand. Holder with sun visor clip on request.

#### With proven Hörmann technology

- More than 1 billion possible radio codes
- Simple transfer of the code from one hand transmitter to the other
- HomeLink compatible (version 7)
- Impact-resistant thanks to the permanently built-in aerial
- Stable range via 868.3 radio frequency

**868,3 MHz**



For garages without a second access door, we offer you the following options for opening your garage door from the outside in an emergency (e.g. in the event of a power failure).

#### For sectional doors without a handle

- Emergency release lock with round cylinder (cannot be mastered with other locks in your home)
- Emergency release handle in a choice of eight styles including lock (can be mastered with other locks in your home)

#### For up-and-over and sectional doors with existing handle

- Emergency release (not illustrated)



#### Receiver

If you switch on additional outdoor lighting and want, for example, to open a garage door (non-Hörmann make) with the hand transmitter, you require a receiver with 1, 2 or 4 channels.



With a digital coder you no longer need to take a key or a remote control with you. And when it's dark, an illuminated digital coder is the ideal solution.



## Accessories for Added Comfort

We accommodate your wishes

In addition to the radio-controlled hand transmitters we offer you a wide range of high-quality stationary control elements in an attractive design. To increase the comfort factor. Your Hörmann specialist dealer will be happy to advise you.



FCT 3b

**Code modulator with illuminated buttons**

Hörmann code modulators are available in two versions, with three or ten possible functions. They are easy to install because you don't need to lay any cables.

The FCT 3b (top illustration) with three functions is protected by a robust flap lid.



FCT 10b

The FCT 10b with ten functions features a weather-resistant membrane keypad.

With the additional functions of the two code modulators, you can, for example, also operate the entrance gate or your outdoor lighting, in addition to controlling your garage door. (Additional receiver required)



**Transponder key switch**

You simply hold the coded transponder key approx. 2 cm in front of the reader. Two keys are included. Further keys are available on request.



**Key switch**

As a flush or surface-mounted version, each with three keys. Includes connecting lead.

**Internal push-button unit with illuminated push-button for the new SupraMatic operators // NEW**

With the IT 1b you open your door via the illuminated button. The IT 3b additionally offers separate control of the operator lighting and the possibility of switching the operator off permanently, e.g. when you are away on holiday.

**Internal radio push-button unit**

The FIT 2 allows you to control two operators or operator functions. It is operated via two impulse buttons or optionally a connected key switch which can be switched off at the FIT 2, e.g. when you are away on holiday.

**Internal push-button unit IT 1 for the ProMatic operators**

With impulse button for opening and closing



**Digital coder with illuminated buttons // NEW**

You simply enter your own personal combination code. With the CTR 3b deluxe version you can open/close a second door or gate as well as switch on the outdoor lighting.

**Flush-mounted radio transmitter**

For all standard 55 mm diameter switch boxes. Ideally, centrally installed in the hall or living room within sight of the garage door. With the two functions you control your garage door and in addition, for example, the outdoor lighting or the pump to the garden pond.



**Photocell**

Vehicles and persons are instantly detected. This rules out collisions and provides a level of safety that particularly families with children appreciate.

**Fingerscan // NEW**

To actuate an operator via fingerprint (up to 99 fingerprints can be learned).



IT 1b

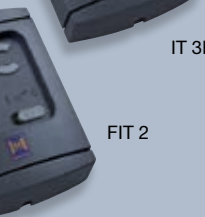

IT 3b



FIT 2



# Technical Data, Installation Details

## For the ProMatic and SupraMatic operators

Technical data	SupraMatic E // NEW	SupraMatic P // NEW	ProMatic	ProMatic P	ProMatic Akku
Peak force	800 N	1000 N	650 N	750 N	400 N
max. door speed	OPEN	22 cm/s	22 cm/s	13 cm/s	13 cm/s
	CLOSE	13 cm/s	13 cm/s	13 cm/s	13 cm/s
Door cycles (open/close) per day	max. 25	max. 50	max. 5	max. 10	max. 4
Operator programming	3 buttons and 7-segment displays on the control unit housing		3 DIP switches on the control unit circuit board		2 DIP switches
Operating lighting	2-minute light can be individually set from 1-5 minutes or switched off altogether		3 minutes light		30 seconds light
Automatic cut-out	Automatically learned separately for both directions and re-adjusting during every door cycle.				
End-of-travel cut-off	Self-learning, wear-free because there are no mechanical switches, additionally with integrated excess travel stop				
Belt relief	automatic/adjustable		automatic		automatic
Force limit	automatic/adjustable		automatic		automatic
"Soft" start/"Soft" stop	automatic/adjustable		adjustable		adjustable
Automatic timer	activated with adjustable hold-open phase		activated with 30 seconds hold-open phase		-
Closing edge safety device	can be connected, with automatic detection adjustable with or without self-monitoring		can be connected		-
Photocell	can be connected, with automatic detection can be set to work with or without self-testing		can be connected		-
Leading photocell VL 2 for garage doors incorporating a wicket door with trip-free threshold	-	can be connected	-	-	-
Warning light	can be connected via an external options relay		can be connected via an external options relay		can be connected via an external options relay
Additional lighting	can be connected via an external options relay can be switched separately with operator lighting		can be connected via an external options relay (coupled with door functions)		can be connected via an external options relay
CLOSE end-of-travel signalling	can be connected via an external options relay		can be connected via an external options relay		-
Factory reset	yes		yes		yes
Remote control	With 4-button hand transmitter HS 4 (868.3 MHz) and separate receiver. Fail-safe radio system with security coding from more than 1 billion options. On the press of a button, easy transfer of the hand transmitter code via a "teaching" function.				
Motor	DC motor with Hall sensor Worm gear and transformer with thermal overload protection Operating mode: S2. Short-term duty: KB 2 min.				
Mains connection	230 / 240 V/AC, 50 / 60 Hz, with CEE phase-changer plug Stand-by approx. 4.5 W				
Fitting	Universal fitting for up-and-over and sectional doors.				
Boom	Extremely flat (only 30 mm high), with integral door security kit and maintenance-free, patented toothed belt. Transport lengths (mm): 1-piece: 3075 (K), 3325 (M), 4000 (L), 2-piece: 1570 (K), 1690 (M), 2020 (L)				
Dimensions (W x H x D)	Operator head: 180 x 120 x 330 mm Cardboard packaging: 195 x 145 x 600 mm				
Shipping weight	Operator head: 6.4 kg Booms: 6.8 (K), 7.4 (M), 8.8 (L)				
Protection category	For dry rooms only				
Use/application	For domestic garages only				

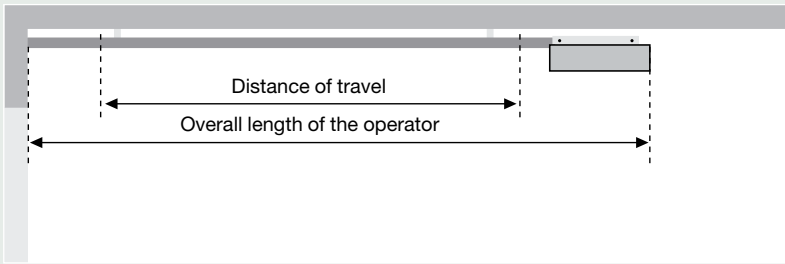

Boom type	Overall length	Distance of travel
<b>K</b> Short boom	3200 mm	2475 mm
<b>M</b> Medium boom	3450 mm	2725 mm
<b>L</b> Long boom	4125 mm	3400 mm

Application range of booms for Hörmann garage doors		
<b>K</b>	“Berry” up-and-over doors (N80 und DF98) Sectional garage doors with N tracks Sectional garage doors with Z, L and H tracks	up to 2500 mm high, up to 2250 mm high, up to 2125 mm high,
<b>M</b>	Berry” up-and-over doors (N80 und DF98) Sectional garage doors with N tracks Sectional garage doors with Z, L and H tracks	up to 2750 mm high, up to 2500 mm high, up to 2375 mm high,
<b>L</b>	Sectional garage doors with N, Z, L and H tracks	up to 3000 mm high

For other door makes  
note distance of travel!

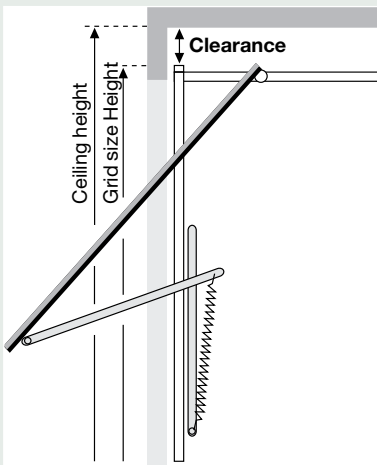

Clearance for “Berry” up-and-over doors	
N80	0 mm
N80, designs 905 and 941 or with timber infill	15 mm
DF98, DF95, DF80	65 mm

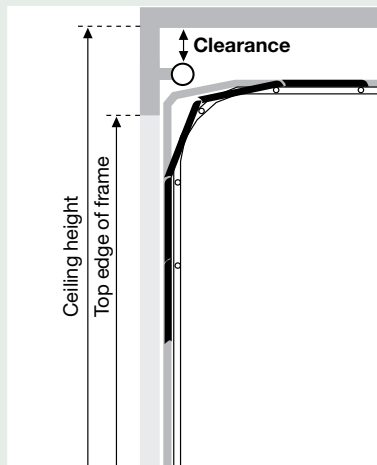

Clearance for sectional garage doors	
with N tracks Ceiling height = Grid size Height + 210 mm	0 mm
with H tracks 0 mm	0 mm

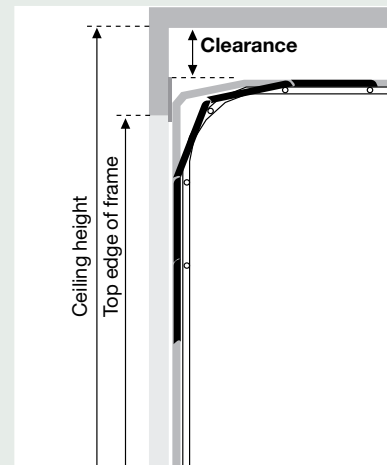

Clearance for sectional garage doors	
with Z tracks Ceiling height = Grid size Height + 115 mm	15 mm
with L tracks Ceiling height = Grid size Height + 115 mm	15 mm

Clearance for other door makes	
between the door's highest point of travel and the ceiling	30 mm

All dimensions are minimum dimensions.

For every door an operator to match from Hörmann

# Hörmann Quality for Entrance Gates and Collective Garages

No entrance gate is really convenient and secure, unless it has been equipped with a remote-controlled operator. And it goes without saying that not just any old operator will do!

It needs to be a quality product that you can rely on day in and day out. When you choose a remote-controlled high-performance operator from Hörmann, you know you are definitely making the right decision because it comes with decades of know-how built in: For your new hinged or sliding gate or for retrofitting to an already existing entrance gate.



#### Hinged gate operator DTA

For doors up to 4000 mm wide and 2000 mm high  
Peak force 1500 N.



#### Sliding gate operator STA

For doors up to 6000 mm wide and 2000 mm high  
Peak force 1500 N.

#### Hörmann SupraMatic H operator

##### The powerful operator for collective garages

This operator with the deluxe accessories for individual solutions is specially geared to the frequent opening and closing of underground and collective garages using up-and-over or sectional doors, for up to 100 operations per day. Peak force 1200 N.

#### Sectional garage doors

In high-grade steel, single or double-skinned and in a variety of timber designs, as automatic doors or manually operated.



All the doors and gates you need for your home



**“Berry” up-and-over doors**

With steel or timber infill, in a wide range of designs, manually operated or as an automatic door.

**Entrance doors and canopies**

High-grade aluminium doors in the fast-track program for the price-conscious builder/home-owner, also with matching entrance door canopies.

**Steel doors**

As a burglar-retardant steel door with multiple locking as a standard feature. As an entrance to the basement, a side door or for the garage.



# Hörmann: Quality without Compromise



Hörmann KG Amshausen



Hörmann KG Antriebstechnik



Hörmann KG Brandis



Hörmann KG Brockhagen



Hörmann KG Dissen



Hörmann KG Eckelhausen



Hörmann KG Freisen



Hörmann KG Ichttershausen



Hörmann KG Werne



Hörmann Genk NV, Belgien



Hörmann Beijing, China



Hörmann Inc. Vonore TN, USA

Hörmann is the only manufacturer worldwide that offers you a complete range of all major building products from one source.

We manufacture in highly-specialized factories using the latest production technologies.

The close-meshed network of sales and service companies throughout Europe, and activities in the USA and China, make Hörmann your strong partner for first-class building products, offering "Quality without Compromise".

**GARAGE DOORS**

**OPERATORS**

**INDUSTRIAL DOORS**

**LOADING EQUIPMENT**

**HINGED DOORS**

**DOOR FRAMES**

**Hörmann (UK) Ltd**, Gee Road, Coalville, Leicestershire LE67 4JW  
Phone (01530) 513000, Fax (01530) 513001

